

FLEXIBILIDAD
EN AGUA Y GAS





Latynflex
CONEXIONES FLEXIBLES

■ GAS

■ AGUA

CONEXIONES FLEXIBLES PARA GAS

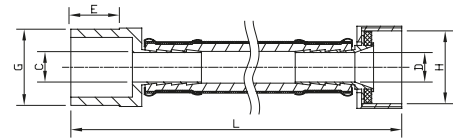

FLEXIBLE MALLADO ACERO INOXIDABLE - GAS LICUADO

MODELO	AF GAS-2600	CÓDIGO	MEDIDA	G (mm)	C (mm)	E (mm)	H (mm)	D (mm)	L (mm)
 	1926001230	1/2x30	1/2" M	7,5	13,5	1/2" H	7,5	300	
	1926001240	1/2x40	1/2" M	7,5	13,5	1/2" H	7,5	400	
	1926001250	1/2x50	1/2" M	7,5	13,5	1/2" H	7,5	500	
	1926001260	1/2x60	1/2" M	7,5	13,5	1/2" H	7,5	600	
	1926001280	1/2x80	1/2" M	7,5	13,5	1/2" H	7,5	800	
	19260012100	1/2x100	1/2" M	7,5	13,5	1/2" H	7,5	1000	
	19260012120	1/2x120	1/2" M	7,5	13,5	1/2" H	7,5	1200	
	19260012150	1/2x150	1/2" M	7,5	13,5	1/2" H	7,5	1500	



Terminales	Bronce, Mec., Niquelado
Tubo	NBR
Malla	Trenzada de 8 hilos de acero inoxidable AISI 304
Guarnición	PTFE
Presión de trabajo	280 mm C.A.
Observaciones	Terminales Engrampados

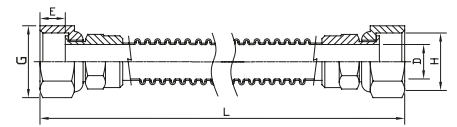

FLEXIBLE ACERO INOXIDABLE GAS NATURAL

MODELO	AF GAS-2700	CÓDIGO	MEDIDA	G (mm)	C (mm)	E (mm)	H (mm)	D (mm)	L (mm)
 	1927001230	1/2x30	1/2" M	12,5	11,5	1/2" H	12,5	300	
	1927001245	1/2x45	1/2" M	12,5	11,5	1/2" H	12,5	450	
	1927001260	1/2x60	1/2" M	12,5	11,5	1/2" H	12,5	600	
	1927001275	1/2x75	1/2" M	12,5	11,5	1/2" H	12,5	750	
	1927001290	1/2x90	1/2" M	12,5	11,5	1/2" H	12,5	900	



Terminales	Bronce, Mec., Niquelado/ AISI 304
Tubo	AISI 316L
Guarnición	PTFE
Pres. Máx. de trabajo	60 mbar
Observaciones	Terminales soldados

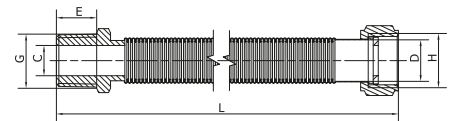

FLEXIBLE EXTENSIBLE GAS NATURAL

MODELO	AF GAS-2800	MEDIDA	G (mm)	C (mm)	E (mm)	H (mm)	D (mm)	L (mm)
 	192800122042	1/2x20/42	1/2" M	12,5	15,5	1/2" H	12,0	200/420
	192800124095	1/2x40/95	1/2" M	12,5	15,5	1/2" H	12,0	400/950
	192800342042	3/4x20/42	3/4" M	18,0	18,0	3/4" H	18,0	200/420
	192800344095	3/4x40/95	3/4" M	18,0	18,0	3/4" H	18,0	400/950



Terminales	Bronce, Mec., Niquelado/ AISI 304
Tubo	AISI 316L
Guarnición	PTFE
Pres. Máx. de trabajo	60 mbar
Observaciones	Terminales soldados

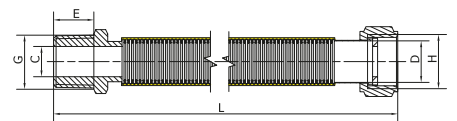

FLEXIBLE EXTENSIBLE REVESTIDO GAS NATURAL

MODELO	AF GAS-2900	CÓDIGO	MEDIDA	G (mm)	C (mm)	E (mm)	H (mm)	D (mm)	L (mm)
 	192900122042	1/2x20/42	1/2" M	12,5	15,5	1/2" H	12,5	200/420	
	192900124095	1/2x40/95	1/2" M	12,5	15,5	1/2" H	12,5	400/950	



Terminales	Bronce, Mec., Niquelado/ AISI 304
Tubo	AISI 316L, con recubrimiento de polietileno para protección a corrosión severa
Guarnición	PTFE
Pres. Máx. de trabajo	60 mbar
Observaciones	Terminales soldados

FLEXIBLE EXTENSIBLE PARA MEDIDORES

MODELO	AF GAS-2810	MEDIDA	G (mm)	C (mm)	E (mm)	H (mm)	D (mm)	L (mm)
 	19281011470	1 1/4"	3/4" M	18,0	18,0	1 1/4" H	18,0	300/700
	19281011870	1 1/8"	3/4" M	18,0	18,0	1 1/4" H	18,0	300/700

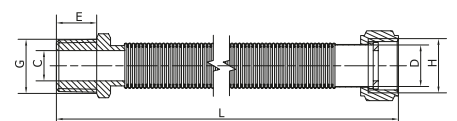

Terminales	Aleación de Aluminio
Tubo	AISI 316L
Pres. Máx. de trabajo	60 mbar
Observaciones	Terminales soldados

FLEXIBLE EXTENSIBLE P/ TERMOTANQUE

MODELO	AF GAS-2820	CÓDIGO	MEDIDA	G (mm)	C (mm)	E (mm)	H (mm)	D (mm)	L (mm)
		19282040105	1/2x3/8X1/4	1/2" M	12,2	15,5	3/8" H	8,2	400/1050

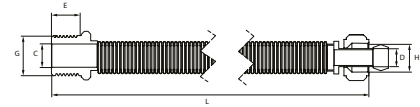

Terminales	Bronce, Mec., Niquelado / AISI 304. Conexión macho 1/2", cierre a virola de 3/8", tuerca giratoria de 3/8"
Tubo	AISI 316L
Guarnición	PTFE
Pres. Máx. de trabajo	60 mbar
Observaciones	Terminales soldados

FLEXIBLE EXTENSIBLE P/ CALEFACTOR

MODELO	AF GAS-2830	CÓDIGO	MEDIDA	G (mm)	C (mm)	E (mm)	H (mm)	D (mm)	L (mm)
		1928302030	1/2x5/16X1/4	1/2" M	14	15,5	1/4" H	6,2	200/420
		1928303050	1/2x5/16X1/4	1/2" M	14	15,5	1/4" H	6,2	300/520

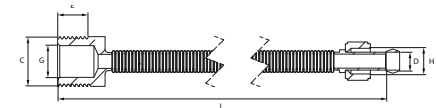

Terminales	Bronce, Mec., Niquelado / AISI 304. Conexión macho 1/2", cierre a virola de 5/16", tuerca giratoria de 1/4"
Tubo	AISI 316L
Guarnición	PTFE
Pres. Máx. de trabajo	60 mbar
Observaciones	Terminales soldados

CONEXIONES FLEXIBLES PARA AGUA
FLEXIBLE MALLADO DE ACERO INOXIDABLE

MODELO	AF-2075	CÓDIGO	MEDIDA	G (pulg.)	C (mm)	E (mm)	H (pulg.)	D (mm)	L (mm)
		1920751220	1/2x20	1/2" M	7	12	1/2" H	7	200
		1920751225	1/2x25	1/2" M	7	12	1/2" H	7	250
		1920751230	1/2x30	1/2" M	7	12	1/2" H	7	300
		1920751235	1/2x35	1/2" M	7	12	1/2" H	7	350
		1920751240	1/2x40	1/2" M	7	12	1/2" H	7	400
		1920751250	1/2x50	1/2" M	7	12	1/2" H	7	500
		1920753420	3/4x20	3/4" M	9,5	14	3/4" H	10	200
		1920753425	3/4x25	3/4" M	9,5	14	3/4" H	10	250
		1920753430	3/4x30	3/4" M	9,5	14	3/4" H	10	300
		1920753435	3/4x35	3/4" M	9,5	14	3/4" H	10	350
		1920753440	3/4x40	3/4" M	9,5	14	3/4" H	10	400
		1920753450	3/4x50	3/4" M	9,5	14	3/4" H	10	500

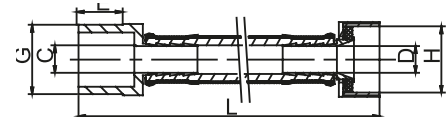

Terminales	Acero Inoxidable AISI 304
Conexiones	BSP
Tubo	EPDM Atóxico
Malla	Trenzada de 8 hilos de acero inoxidable
Guarnición	NBR
Observaciones	Terminales engrampados

FLEXIBLE MALLADO ACERO INOXIDABLE MACHO GIRATORIO C/ LLAVE DE AJUSTE PLÁSTICA

MODELO	AF-2076	CÓDIGO	MEDIDA	G (pulg.)	C (mm)	E (mm)	H (pulg.)	D (mm)	L (mm)
		1920761220	1/2x20	1/2" M	7	13,5	1/2" H	7	200
		1920761225	1/2x25	1/2" M	7	13,5	1/2" H	7	250
		1920761230	1/2x30	1/2" M	7	13,5	1/2" H	7	300
		1920761235	1/2x35	1/2" M	7	13,5	1/2" H	7	350
		1920761240	1/2x40	1/2" M	7	13,5	1/2" H	7	400
		1920761250	1/2x50	1/2" M	7	13,5	1/2" H	7	500
		1920763420	3/4x20	3/4" M	12	14	3/4" H	10	200
		1920763425	3/4x25	3/4" M	12	14	3/4" H	10	250
		1920763430	3/4x30	3/4" M	12	14	3/4" H	10	300
		1920763435	3/4x35	3/4" M	12	14	3/4" H	10	350
		1920763440	3/4x40	3/4" M	12	14	3/4" H	10	400
		1920763450	3/4x50	3/4" M	12	14	3/4" H	10	500

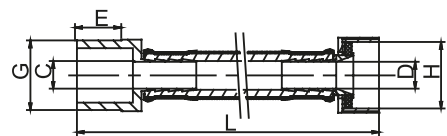

Terminales	Acero Inoxidable AISI 304
Conexiones	BSP
Tubo	EPDM Atóxico
Malla	Trenzada de 8 hilos de acero inoxidable
Guarnición	NBR
Observaciones	Terminales engrampados

GAS

AGUA

CONEXIONES FLEXIBLES PARA AGUA

FLEXIBLE MALLADO

MODELO	AF-2078	CÓDIGO	MEDIDA	G (pulg.)	C (mm)	E (mm)	H (pulg.)	D (mm)	L (mm)
		1920781220	1/2x20	1/2" M	7	11,5	1/2" H	7,0	200
		1920781225	1/2x25	1/2" M	7	11,5	1/2" H	7,0	250
		1920781230	1/2x30	1/2" M	7	11,5	1/2" H	7,0	300
		1920781235	1/2x35	1/2" M	7	11,5	1/2" H	7,0	350
		1920781240	1/2x40	1/2" M	7	11,5	1/2" H	7,0	400
		1920781250	1/2x50	1/2" M	7	11,5	1/2" H	7,0	500
		1920783420	3/4x20	3/4" M	9,5	13,0	3/4" H	10,2	200
		1920783425	3/4x25	3/4" M	9,5	13,0	3/4" H	10,2	250
		1920783430	3/4x30	3/4" M	9,5	13,0	3/4" H	10,2	300
		1920783435	3/4x35	3/4" M	9,5	13,0	3/4" H	10,2	350
		1920783440	3/4x40	3/4" M	9,5	13,0	3/4" H	10,2	400
		1920783450	3/4x50	3/4" M	9,5	13,0	3/4" H	10,2	500

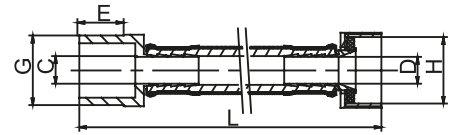

Terminales	Acero Inoxidable AISI 304
Tubo	EPDM Atóxico
Malla	Trenzada de 8 hilos de aluminio
Guarnición	NBR
Observaciones	Terminales Engrampados

FLEXIBLE MALLADO ACERO INOX. P/BOMBA

MODELO	AF-2074	CÓDIGO	MEDIDA	G (pulg.)	C (mm)	E (mm)	H (pulg.)	D (mm)	L (mm)
		1920740150	1x50	1" M	19,8	11,1	1" H	19,8	500

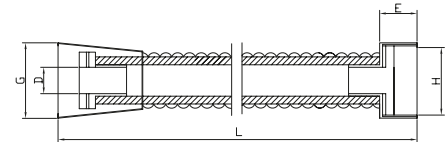

Terminales	Bronce, Mecanizado, Niquelado
Conexiones	BSP
Tubo	EPDM Atóxico
Malla	Trenzada de acero inoxidable
Guarnición	NBR
Observaciones	Terminales engrampados

FLEXIBLE MALLADO NYLON CON MARIPOSA

MODELO	AF-2079	CÓDIGO	MEDIDA	G (pulg.)	C (mm)	E (mm)	H (pulg.)	D (mm)	L (mm)
		1920791220	1/2x20	1/2" M	14,5	13,5	1/2" H	15	200
		1920791225	1/2x25	1/2" M	14,5	13,5	1/2" H	15	250
		1920791230	1/2x30	1/2" M	14,5	13,5	1/2" H	15	300
		1920791235	1/2x35	1/2" M	14,5	13,5	1/2" H	15	350
		1920791240	1/2x40	1/2" M	14,5	13,5	1/2" H	15	400
		1920791250	1/2x50	1/2" M	14,5	13,5	1/2" H	15	500
		1920793420	3/4x20	3/4" M	18,5	16	3/4" H	18	200
		1920793425	3/4x25	3/4" M	18,5	16	3/4" H	18	250
		1920793430	3/4x30	3/4" M	18,5	16	3/4" H	18	300
		1920793435	3/4x35	3/4" M	18,5	16	3/4" H	18	350
		1920793440	3/4x40	3/4" M	18,5	16	3/4" H	18	400
		1920793450	3/4x50	3/4" M	18,5	16	3/4" H	18	500

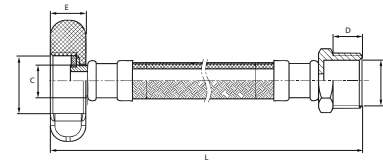

Terminales	Bronce, Mariposa de POM
Conexiones	BSP
Tubo	Trenzada de Nylon
Guarnición	NBR
Terminación	Recocido
Observaciones	Terminales engrampados, mariposa para ajuste manual

FLEXIBLE ANILLADO DE ACERO INOXIDABLE

MODELO	AF-2084	CÓDIGO	MEDIDA	G (pulg.)	C (mm)	E (mm)	H (pulg.)	D (mm)	L (mm)
		1920841220	1/2x20	1/2" M	14,5	10	1/2" H	14,5	200
		1920841225	1/2x25	1/2" M	14,5	10	1/2" H	14,5	250
		1920841230	1/2x30	1/2" M	14,5	10	1/2" H	14,5	300
		1920841235	1/2x35	1/2" M	14,5	10	1/2" H	14,5	350
		1920841240	1/2x40	1/2" M	14,5	10	1/2" H	14,5	400
		1920841250	1/2x50	1/2" M	14,5	10	1/2" H	14,5	500
		1920843420	3/4x20	3/4" M	18,5	13	3/4" H	18,5	200
		1920843425	3/4x25	3/4" M	18,5	13	3/4" H	18,5	250
		1920843430	3/4x30	3/4" M	18,5	13	3/4" H	18,5	300
		1920843435	3/4x35	3/4" M	18,5	13	3/4" H	18,5	350
		1920843440	3/4x40	3/4" M	18,5	13	3/4" H	18,5	400
		1920843450	3/4x50	3/4" M	18,5	13	3/4" H	18,5	500

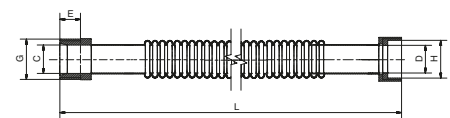

Terminales	Bronce, Mecanizado.
Conexiones	BSP
Tubo	Acero Inoxidable, Anillado.
Guarnición	NBR
Terminación	Recocido, Pullido
Observaciones	Terminales soldados, hembra movil

FLEXIBLE DE COBRE ANILLADO CROMADO

MODELO	AF-2080	CÓDIGO	MEDIDA	G (pulg.)	C (mm)	E (mm)	H (pulg.)	D (mm)	L (mm)
		19208012201	1/2x20	1/2" M	14	13	1/2" H	13,5	200
		19208012251	1/2x25	1/2" M	14	13	1/2" H	13,5	250
		19208012301	1/2x30	1/2" M	14	13	1/2" H	13,5	300
		19208012351	1/2x35	1/2" M	14	13	1/2" H	13,5	350
		19208012401	1/2x40	1/2" M	14	13	1/2" H	13,5	400
		19208012501	1/2x50	1/2" M	14	13	1/2" H	13,5	500
		19208034201	3/4x20	3/4" M	18	13	3/4" H	18	200
		19208034251	3/4x25	3/4" M	18	13	3/4" H	18	250
		19208034301	3/4x30	3/4" M	18	13	3/4" H	18	300
		19208034351	3/4x35	3/4" M	18	13	3/4" H	18	350
		19208034401	3/4x40	3/4" M	18	13	3/4" H	18	400
		19208034501	3/4x50	3/4" M	18	13	3/4" H	18	500

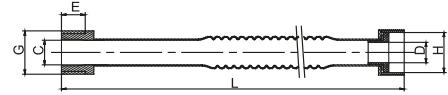

Terminales	Bronce, Mec., Niquelado
Conexiones	BSP
Tubo	Cobre de Alta Dureza, Anillado
Guarnición	NBR
Observaciones	Terminales soldados, Hembra móvil

FLEXIBLE P/MONOCOMANDO POR 2 UN.

MODELO	AF-2071	CÓDIGO	MEDIDA	G (mm)	C (mm)	E (mm)	H (mm)	L (mm)
		1920711040	1/2x40	1/2" H	39	17	M 10*1	400
		1920710840	1/2x40	1/2" H	39	17	M 8*1	400
		1920711240	1/2x40	1/2" H	39	17	M 1/2*1	400

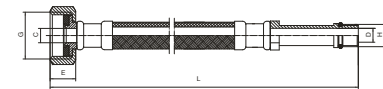

Terminales	Bronce, Mec., Niquelado
Conexiones	BSP
Tubo	EPDM Atóxico
Malla	Trenzada de acero inoxidable
Guarnición	NBR
Observaciones	Terminales engrapados

FLEXIBLE P/MONOCOMANDO MACHO GIRATORIO POR 2 UN.

MODELO	AF-2072	CÓDIGO	MEDIDA	G (pulg.)	C (mm)	E (mm)	H (pulg.)	L (mm)
		1920721040	1/2x40	1/2" M	39	17	M 10*1	400

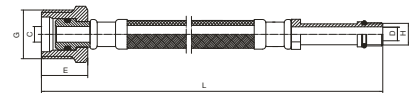

Terminales	Bronce, Mec., Niquelado
Conexiones	BSP
Tubo	EPDM Atóxico
Malla	Trenzada de acero inoxidable
Guarnición	NBR
Observaciones	Terminales engrapados

FLEXIBLE DE PVC

MODELO	AF-2095	CÓDIGO	MEDIDA	G (pulg.)	C (mm)	E (mm)	H (pulg.)	D (mm)	L (mm)
		1920951230	1/2x30	1/2" M	7,0	13	1/2" H	7	300
		1920951240	1/2x40	1/2" M	7,0	13	1/2" H	7	400
		1920951250	1/2x50	1/2" M	7,0	13	1/2" H	7	500

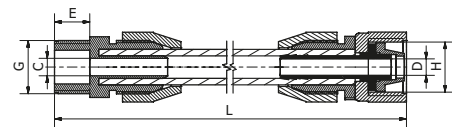

Terminales	Plásticos
Tubo	PVC
Observaciones	PVC color blanco

ROSETA METÁLICA PARA FLEXIBLE MALLADO

MODELO	AF-2270	CÓDIGO	MEDIDA
		19227012	1/2"
		17227034	3/4"



■ GAS

■ AGUA

DESCARGAS Y SIFONES

DESCARGA FLEXIBLE PARA LAVATORIO CON ADAPTADOR

MODELO	AF-2100	CÓDIGO	MEDIDA	L (mm)	A* (mm)	B* (mm)
		19210011440	1/4x40	500	110	210



A: mínima 35mm / máxima 110mm.
B: mínima 70mm / máxima 210mm.

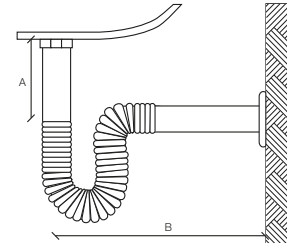

SIFÓN FLEXIBLE PARA LAVATORIO CON ADAPTADOR

MODELO	AF-2900	CÓDIGO	MEDIDA	L (mm)	A* (mm)	B (mm)
		362900	1 1/4-40	500	85/160	390



(*) A: mínima 85mm / máxima 160mm.

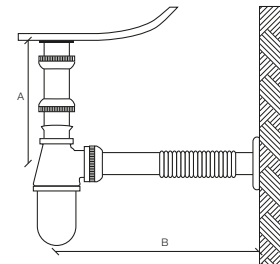

SIFÓN RÍGIDO PARA LAVATORIO CON ADAPTADOR

MODELO	AF-2950	CÓDIGO	MEDIDA	L (mm)	A* (mm)	B (mm)
		362800	1 1/4-40	500	85/160	390



(*) A: mínima 85mm / máxima 160mm.

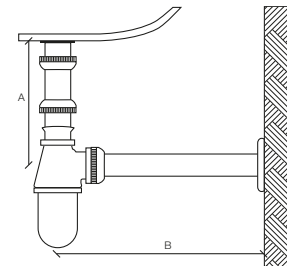

SIFÓN CUADRADO PREMIUM

MODELO	AF-2955	CÓDIGO	MEDIDA	L (mm)	A* (mm) min/máx	B* (mm) min/máx
		362955	1 1/4	500	110	350



A: máxima 110mm.
B: máxima 350mm.

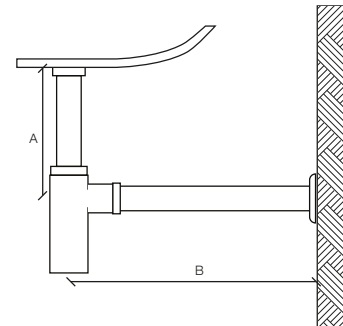

SIFÓN CILÍNDRICO PREMIUM

MODELO	AF-2956	CÓDIGO	MEDIDA	L (mm)	A* (mm) min/máx	B* (mm) min/máx
		362956	1 1/4-40	500	110	350



A: máxima 110mm.
B: máxima 350mm.

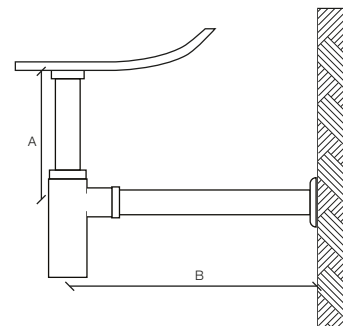



Todas las soluciones para agua y gas

FLEXIBLES EXTENSIBLES DE 15 A 30 CM



Acero
Inoxidable



Conexión
extensible
15 a 30 cm



Fácil de
instalar



Flexible

+seguros
+estéticos

MATRÍCULA
N° 1583-43



Instituto del
Gas Argentino



GAS

AGUA

DESCARGA RÍGIDA PARA LAVATORIO CON ADAPTADOR

MODELO	AF-2150	CÓDIGO	MEDIDA	A (mm)	B (mm)	C (mm)
		1921502530	25 x 30	25	30	32
		1921504040	40 x 40	40	40	32

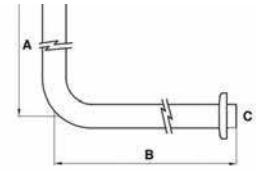

Cuerpo	Tubo Acero Inoxidable
Sellos	NBR
Conexión caños	PVC
Terminación	Cromado, Pulido

CONEXIÓN FLEXIBLE PARA INODORO CON ADAPTADOR

MODELO	AF-2200	CÓDIGO	MEDIDA	L (mm)	A (mm)	B (mm)	C (mm)	G (mm)
		192200	1 1/4-40mm	200	73	80	32	40

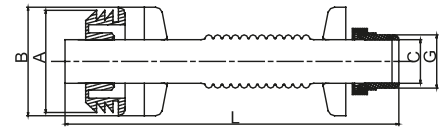

Cuerpo	Tubo de Cobre de Alta Pureza y recocado
Sellos	NBR
Conexión caños	PVC
Terminación	Cromado, Pulido

CONEXIÓN RÍGIDA PARA INODORO CON ADAPTADOR

MODELO	AF-2300	CÓDIGO	MEDIDA	L (mm)	A (mm)	B (mm)	C (mm)
		192300	1 1/4-40mm	200	73	80	38

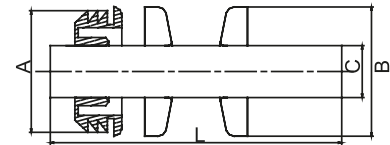

Cuerpo	Tubo de Cobre de alta pureza y recocado
Sellos	NBR
Conexión caños	PVC
Terminación	Cromado, Pulido

ENTRADA PARA MINGITORIO CON ADAPTADOR

MODELO	AF-2400	CÓDIGO	MEDIDA (PUL. x mm)	L (mm)	A (mm)	B (mm)	C (mm)	G (mm)
		192400	1/2x300mm	300	43	60	15	1/2

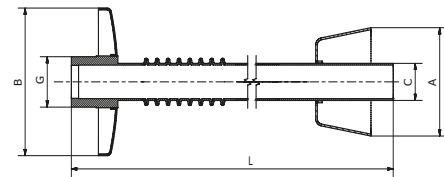

Cuerpo	Tubo de Cobre de Alta Pureza y recocado
Sellos	NBR
Conexión caños	PVC
Terminación	Cromado, Pulido

DESCARGA PARA MINGITORIO CON ADAPTADOR

MODELO	AF-2500	CÓDIGO	MEDIDA	L (mm)	A (mm)	B (mm)	C (mm)	G (mm)
		192500	1 1/4-320mm	320	60	80	32	40

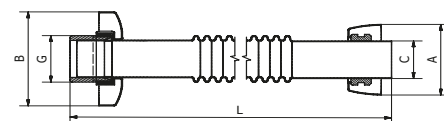

Cuerpo	Tubo de Cobre de Alta Pureza y recocado
Sellos	NBR
Conexión caños	PVC
Terminación	Cromado, Pulido